

Архангельск (8182)63-90-72
 Астана (7172)727-132
 Астрахань (8512)99-46-04
 Барнаул (3852)73-04-60
 Белгород (4722)40-23-64
 Брянск (4832)59-03-52
 Владивосток (423)249-28-31
 Волгоград (844)278-03-48
 Вологда (8172)26-41-59
 Воронеж (473)204-51-73
 Екатеринбург (343)384-55-89
 Иваново (4932)77-34-06

Ижевск (3412)26-03-58
 Иркутск (395)279-98-46
 Казань (843)206-01-48
 Калининград (4012)72-03-81
 Калуга (4842)92-23-67
 Кемерово (3842)65-04-62
 Киров (8332)68-02-04
 Краснодар (861)203-40-90
 Красноярск (391)204-63-61
 Курск (4712)77-13-04
 Липецк (4742)52-20-81
 Киргизия (996)312-96-26-47

Магнитогорск (3519)55-03-13
 Москва (495)268-04-70
 Мурманск (8152)59-64-93
 Набережные Челны (8552)20-53-41
 Нижний Новгород (831)429-08-12
 Новокузнецк (3843)20-46-81
 Новосибирск (383)227-86-73
 Омск (3812)21-46-40
 Орел (4862)44-53-42
 Оренбург (3532)37-68-04
 Пенза (8412)22-31-16
 Казахстан (772)734-952-31

Пермь (342)205-81-47
 Ростов-на-Дону (863)308-18-15
 Рязань (4912)46-61-64
 Самара (846)206-03-16
 Санкт-Петербург (812)309-46-40
 Саратов (845)249-38-78
 Севастополь (8692)22-31-93
 Симферополь (3652)67-13-56
 Смоленск (4812)29-41-54
 Сочи (862)225-72-31
 Ставрополь (8652)20-65-13
 Таджикистан (992)427-82-92-69

Сургут (3462)77-98-35
 Тверь (4822)63-31-35
 Томск (3822)98-41-53
 Тула (4872)74-02-29
 Тюмень (3452)66-21-18
 Ульяновск (8422)24-23-59
 Уфа (347)229-48-12
 Хабаровск (4212)92-98-04
 Челябинск (351)202-03-61
 Череповец (8202)49-02-64
 Ярославль (4852)69-52-93

<https://vma.nt-rt.ru> || vam@nt-rt.ru

КАТАЛОГ

V-9999E New electronic lockstitch	01
V-9999F New electronic lockstitch 2 more type	02
V-9990E/9900E/9600DY Electronic lockstitch common type	03
V-9100E Direct drive lockstitch	04
V-8700/6150/202D/202 Conventional lockstitch	05
V-9310DY Needle bar feed lockstitch	06
V-9900L/V-9900XL Long arm lockstitch	06
V-58720E-405 Double needle machine	07
V-5559E Lockstitch with edge cutter	08
V-8558D Chain stitch machine	09



OVERLOCK MACHINE

V-90AT New overlock	11
V-798D Overlock needle bar closed	12
V-804D/747 Overlock basic type	13
V-788D Overlock better quality	14
V-998D/998T Overlock high class	15
V-997D overlock cylinder bed	16



INTERLOCK MACHINE

V-858T Interlock top differential transport	17
V-858D Interlock thread cam outside	17
V-562E Interlock flat bed electronic	18
V-562AT-02BB/05CB Special flat bed interlock	19
V-664D Interlock cylinder bed electronic	20
V-664D-35AC Interlock cylinder bed bottom hemming	21
V-80D Interlock new design	22
V-7600D Interlock smallest sewing bed	22



SPECIAL MACHINE

V-5878-58B Placket setting	24
V-12080D Programmable large area	25
V-3020/2210/1310D Pattern sewing	26
V-430D/1906A Electronic bar tacking	27
V-1790 Electronic button holing	28
V-9820 Eyelet button holing	28
V-781 Button holing	29
V-373 Button attach	30
V-1850 Bar tacking	31
V-9280 Feed off the arm	31



OTHER SPECIAL MACHINE

V-T20U53 Zigzag	32
V-2284D/2290SR Zigzag electronic	33
V-6200D Four needle six thread	34
V-500/511 Blind stitch	35
V-6000D Imitation button holing	36
V-63900 Trousers hemming	36
V-T588/T388 Hand stitch	37
V-818 Big button attach machine	38
V-T26-1A Bag closer and small machines	39
V-DO30 Domestic machine	40



MULTI-NEEDLE MACHINE

V-1412ATE Electronic multi-needle	41
V-1404D Flat bed type multi-needle	42
V-008VCD Cylinder bed type multi-needle	43
V-13024WD Special multi-needle	44



SHOES & LEATHER MACHINE

V-69910E Post bed machine high quality	45
V-68810 Post bed machine	46
V-62681 Cylinder bed compound feed	47
V-0302 Top & Bottom feed (double transport)	48
V-6668/5942 Compound feed (triple transport)	49
V-60698 Long arm machine triple transport	49
V-2972/168/T801 Shoes machine	50
V-4-5 Fur sewing	51
V-207 Innerside trimming	52



CUTTING MACHINE

V-T801A/T911/803AT Cutting cloth strap	53
V-BK700/900/1200 Band knife	54
V-T3/T103 Straight knife cutting	55
V-T125D/T100 Small round knife	56
V-TDB3 End cutter	57
V-110LR/120HL Belt looper cutter	57



OTHER TEXTILE MACHINE

V-F450(500/600) Fusing machine	58
V-38x38 Heat transfer printing	59
V-TDZ-B1/B7 Ironing table	60
V-DLD6-0.4-F1 Electrically-heated steam boiler	61
V-SP801 Steam press machine	62
V-ST1800PHQ Plotter machine	63
V-LS9060 Laser cutting machine	64
V-1201/1202 Embroidery machine	65
V-906 Embroidery machine multi-heads	66
V-52S Flat knitting machine	67



ACCESSORIES	68
--------------------	----

V-9999E

ELECTRONIC LOCKSTITCH TOUCH SCREEN



											
V-9999E	DBX1 11-18#	2	5	0	5-13	4500	0	0	0	630x245x540	33/36



Valuable Machine Accompany with you!



V-9999F

ELECTRONIC LOCKSTITCH TOUCH SCREEN



- 1) Double knife trimmer system, 3mm
- 2) Closed oil pan, less pollution
- 3) Touch screen

V-9999F	DBX1 11-18#	2	5	○	5-13	4500	○	○	○	630x245x540	33/36



Valuable Machine Accompany with you!



V-9990E

ELECTRONIC LOCKSTITCH CONTROL PANEL BUILT IN TYPE



- 1) Machine body 2KG more heavy
- 2) Beautiful design

ELECTRONIC LOCKSTITCH INTEGRITY



V-9900E QiXing control box



V-9600DY-4 Powermax control box

												NW / GW Kg
V-9990E	DBX1 11-18#	2	5	○	5-13	4500	○	○	○	655x245x540	38/45	
V-9900E	DBX1 11-18#	2	5	/	5-13	4500	○	○	○	635x245x550	34.5/41.5	
V-9600DY-4	DBX1 11-18#	2	5	/	5-13	4500	○	○	○	635x245x550	34.5/41.5	











Valuable Machine Accompany with you!



V-9100E

- 1) Control box built-in machine body
- 2) With needle position function
- 3) Speed adjustable save energy 70%



			 mm	 mm	 S.p.m	 mm	 NW / GW Kg
V-9100E	DBX1 11-18#	2	5	5-13	5000	590x230x550	29.5/36.5
V-9100EH	DBX1 19-23#	2	5	5-13	4000	590x230x550	29.5/36.5



Valuable Machine Accompany with you!











V-8700 / V-6150 / V-202D / V-202

CONVENTIONAL LOCKSTITCH



- 1) V-8700-7 is 7mm stitch length
- 2) V-8700H-7 is heavy duty with 7mm stitch length
- 3) V-202 Heavy duty sewing machine 8mm stitch length big hook

			 mm	 mm	 S.p.m	 mm	 NW / GW Kg
V-8700	DBX1 11-18#	2	5	5-13	5000	590x230x550	29.5/36.5
V-6150	DBX1 11-18#	2	5	5-13	5000	590x230x550	29.5/36.5
V-202D	DPX5 16-20#	2	9	6-13	2500	580x250x530	29.5/34.5
V-202	DPX5 16-20#	2	9	6-13	2500	580x250x530	29.5/34.5



Valuable Machine Accompany with you!



V-9310DY

NEEDLE BAR FEED ELECTRONIC LOCKSTITCH



- 1) Needle bar feeding
- 2) Oil pump lubrication
- 3) Full function with big solenoid presser foot lifter at back.

			mm		mm	S.p.m				mm	Kg	
V-9310DY	DBX1	11-18#	2	5	/	5-13	4500	○	○	○	635x245x550	34.5/41.5
V-9310DYB	DBX1	18-21#	2	5	○	5-13	3500	○	○	○	680x290x590	45/39

V-9900L/V-9900XL

LONG ARM ELECTRONIC LOCKSTITCH MACHINE

- 1) With big operate space V-9900L is 56cm × 16cm; V-9900LX is 80cm × 16cm
- 2) Presser foot lifter height reach to 2.6cm
- 3) With pulley which make transport more smoothly even working during the revers back sewing, also can adjust the speed of pulley
- 4) With air vacuum table, more easy to operate for big size cloth
- 5) After trimmer needle bar automatic raised up to avoid collision with plates



			mm		mm	S.p.m					mm	Kg
V-9900L	DBX1	11-18#	2	5	/	5-13	4500	○	○	○	1150x370x650	65/70
V-9900XL	DBX1	18-21#	2	5	○	5-13	3500	○	○	○	1500x370x650	82/90



Valuable Machine Accompany with you!



V-58720E-405

ELECTRONIC DOUBLE NEEDLE MACHINE



- 1) Straight knife trimmer system, cutting perfect for heavy thread
- 2) Full function with auto-presser foot lifter
- 3) V-58420E-405 electronic/ V-8420D-005 direct drive with needle position / V-8420 conventional with auto-lubrication
- 4) V-58420E/ V-8420D / V-8420 small hook fixed needle bar
 V-58450E/ V-8450D / V-8450 small hook split needle bar
 V-58720E/ V-8720D / V-8720 big hook fixed needle bar
 V-58750E/ V-8750D / V-8750 big hook split needle bar

			mm		S.p.m					mm	Kg
V-58420E-405	DPX5 11-22#	4	7-13	○	4000	○	○	○	○	725x320x675	50/55
V-58450E-405	DPX5 11-22#	4	7-13	○	3000	○	○	○	○	725x320x675	50/55
V-58720E-405	DPX5 11-22#	4	7-13	○	3500	○	○	○	○	725x320x675	50/55
V-58750E-405	DPX5 11-22#	4	7-13	○	3000	○	○	○	○	725x320x675	50/55



Valuable Machine Accompany with you!











V-5559E

LOCKSTITCH WITH EDGE CUTTER



- 1) With edge cutter knife
- 2) Could chose electronic suction device
- 3) V-5559D direct drive with needle position
- 4) V-5559 conventional one

			 mm	 mm	 S.p.m	 mm	 NW / GW Kg
V-5559E	DBX1 11-18#	2	4	5-13	4500	590x270x550	33/40.5
V-5559D-4	DBX1 11-18#	2	4	5-13	4500	635x245x550	34.5/41.5



Valuable Machine Accompany with you!











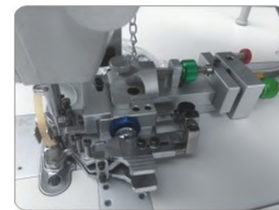

V-8558D

CHAIN STITCH MACHINE



- 1) Suitable for lapping seam and decorative stitching on garments, under-wear, beddings, thin package and leather goods.
- 2) V-8558-1/2/3 is double or single needle
- 3) V-8560 is 3 needles
- 4) Can put with pulley, also can match with direct drive motor
- 5) V-A9-EL is for sweater joint sewing



			 mm	 mm	 S.p.m	 mm	 mm	 NW / GW Kg
V-8558D-1	9-21#	4	4	8-10	4500	1/4"	625x250x565	33.5/41
V-8558D-2	9-21#	2	4	8-10	4500	/	625x250x565	33.5/41
V-8560D	9-21#	6	4	8-10	4500	1/4"	625x250x565	33.5/41
V-A9-EL	9-21#	6	4	8-10	4500	1/4"	1200x800x800	180/150

Valuable Machine Accompany with you!



OVERLOCK & INTERLOCK SEWING MACHINE SERIES



VMA SEWING MACHINE



Valuable Machine Accompany with you!



V-90AT

OVERLOCK NEW DESIGN TOP QUALITY



- 1) High definition LCD screen
- 2) Very easy and clear operation, all parameters shows on screen with explain
- 3) Auto detect material, sewing heavy duty automatic change to be lower speed, make sure high quality of sewing product.
- 4) With design speed 8000rpm (actually 6000~6500 without problem)
- 5) Full function automatic sewing, with electronic or pneumatic
- 6) All the operation with voice mention, also can play music.

												NW / GW Kg
V-90AT-3	DC × 27# 9	1	3	-	4	3.6	0.7-2	5.5	6500	515x355x566	35/40	
V-90AT-4	DC × 27# 11	2	4	2	4	3.6	0.7-2	6	6500	515x355x566	35/40	
V-90AT-5	DC × 27# 14	2	5	3	5	3.6	0.7-2	6	6500	515x355x566	35/40	
V-90AT-5H	DC × 27# 19	2	5	5	6	5	0.7-1.4	6	6000	515x355x566	35/40	



Valuable Machine Acompany with you!



V-798D

OVERLOCK DIRECT DRIVE



- 1) Needle bar system closed, prevent oil leakage
- 2) Direct drive save energy
- 3) With needle position function
- 4) Speed adjustable
- 5) Stable and noise smaller

	DC × 27#								mm	S.p.m	mm	Kg
V-798D-3	9	1	3	-	4	3.6	0.7-2	5.5	6000	460x350x560	30/36	
V-798D-4	11	2	4	2	4	3.6	0.7-2	6	6000	460x350x560	30/36	
V-798D-5	14	2	5	3	5	3.6	0.7-2	6	5500	460x350x560	30/36	
V-798D-5H	19	2	5	5	6	5	0.7-1.4	6	5000	450x360x560	30/36	



Valuable Machine Accompany with you!



V-804D

OVERLOCK DIRECT DRIVE



	DC × 27#								mm	S.p.m	mm	Kg
V-803D	9	1	3	-	4	3.6	0.7-2	5.5	6000	465x340x500	29/35	
V-804D	11	2	4	2	4	3.6	0.7-2	6	6000	465x340x500	29/35	
V-805D	14	2	5	3	5	3.6	0.7-2	6	5500	465x340x500	29/35	
V-805HD	19	2	5	5	6	5	0.7-1.4	6	5000	465x340x500	29/35	

V-747

OVERLOCK CONVENTIONAL



	DC × 27#							mm	S.p.m	mm	Kg
V-737-504M2-04	9	1	3	-	4	3.6	0.7-2	5.5	6000	470x330x480	26.5/3.4.5
V-747-514M2-24	11	2	4	2	4	3.6	0.7-2	6	6000	470x330x480	26.5/3.4.5
V-757-516M2-35	14	2	5	3	5	3.6	0.7-2	6	5500	470x330x480	26.5/3.4.5
V-757-516 × 2-56	19	2	5	5	6	5	0.7-1.4	6	5000	470x330x480	26.5/3.4.5



Valuable Machine Accompany with you!



V-788D

OVERLOCK BETTER QUALITY



With speed 6500RPM, sewing more stable, combine M700 and M800 advantages

	DC × 27#							mm	S.p.m	mm	Kg
V-788D-3	9	1	3	-	4	0.5-3.8	0.7-1.7	5.5	6500	460x350x560	30/36
V-788D-4	11	2	4	2	4	0.5-3.8	0.7-1.7	5.5	6500	460x350x560	30/36
V-788D-5	14	2	5	3	5	0.5-3.8	0.7-1.7	5.5	6000	460x350x560	30/36
V-788D-5H	19	2	5	5	6	0.5-3.8	0.6-1.3	5.5	5500	460x350x560	30/36



Valuable Machine Accompany with you!



V-998D

OVERLOCK TOP QUALITY



- 1) With design speed 8000RPM
- 2) Closed needle bar system avoid oil leakage
- 3) Knife system more stronger and operate space higher
- 4) Spare parts with top quality

V-998TD

TOP DIFFERENTIAL OVERLOCK



- 1) With top feed mechanism, top and bottom separately feed, suitable for 2 different materials sewing.
- 2) Could be direct drive, also can produce full automatic type.

								mm	S.p.m		mm	Kg
V-998D-3	Dc × 27# 9	1	3	-	3-5	3.8	0.7-2	5	8000		515x355x566	35/40
V-998D-4	DC × 27# 11	2	4	2	5-6	3.8	0.7-2	5.5	7500		515x355x566	35/40
V-998D-5	DC × 27# 11	2	5	3	5-6	3.8	0.7-2	5.5	7000		515x355x566	35/40
V-998D-5H	DC × 27# 19	2	5	5	5-6	5	0.8-1.5	7	6500		515x355x566	35/40



V-997D

CLINDER BED OVERLOCK

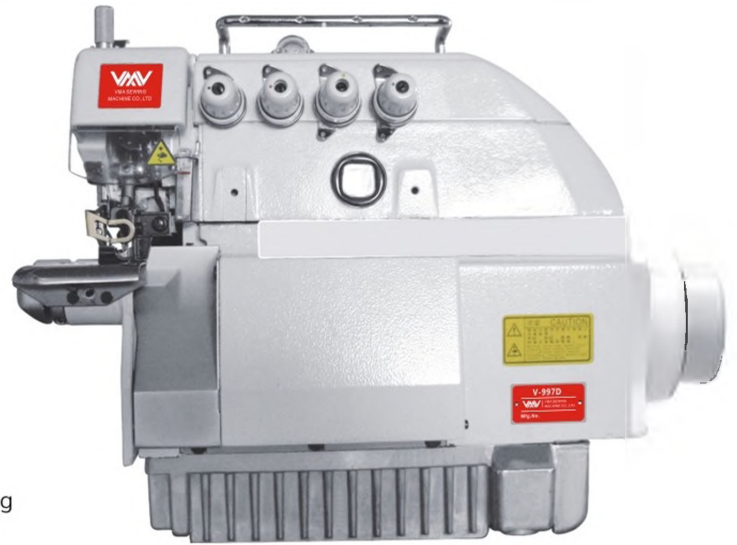

- 1) High design speed 7000rpm
- 2) Can chose the cloth expand system to finish the special sewing such as children' s sleeve and so on.

												NW/GW Kg
V-997D-3-FR01	DC × 27# 9	1	3	-	3-5	3.8	0.7-2	5	8000	472x495x360	24.1/32.6	
V-997D-3H-FR01	DC × 27# 11	1	3	2	5-6	3.8	0.7-2	5.5	7500	472x495x360	24.1/32.6	
V-997D-4-FR01	DC × 27# 11	2	4	3	5-6	3.8	0.7-2	5.5	7000	472x495x360	24.1/32.6	
V-997D-4H-FR01	DC × 27# 19	2	4	5	5-6	5	0.8-1.5	7	6500	472x495x360	24.1/32.6	

V-6900E

FULL AUTOMATIC OVERLOCK TOP QUALITY



- 1) With sensor for automatic sewing
- 2) With trimmer to cut thread
- 3) With presser foot lifter function
- 4) With panel to control parameters
- 5) Top quality spare parts

												NW/GW Kg
V-6900E-3	Dc × 27# 9	1	3	-	3-5	3.8	0.7-2	5	8000	515x355x566	35/40	
V-6900E-4	DC × 27# 11	2	4	2	5-6	3.8	0.7-2	5.5	7500	515x355x566	35/40	
V-6900E-5	DC × 27# 11	2	5	3	5-6	3.8	0.7-2	5.5	7000	515x355x566	35/40	
V-6900E-5H	DC × 27# 19	2	5	5	5-6	5	0.8-1.5	7	6500	515x355x566	35/40	



Valuable Machine Accompany with you!



V-F858T

INTERLOCK TOP FEED MACHINE

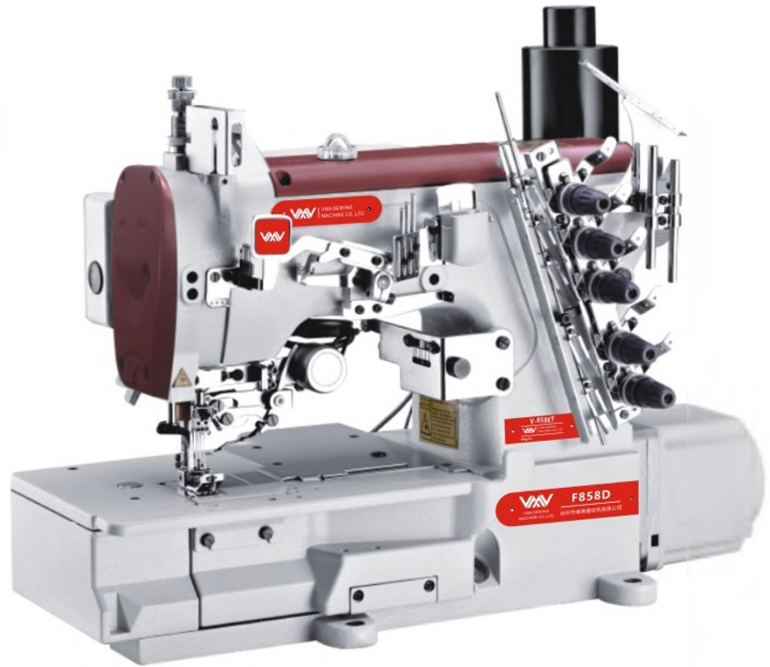

V-858D

INTERLOCK DIRECT DRIVE



Heart outside design more convenience

												NW / GW Kg
V-858D-01GB	# 9-11	3	5	364/356	4.4	0.5-3.8	0.5-1.3	5.5	6000	580x380x630	45/50	
V-858D-02BB	# 9-11	3	5	364/356	4.4	0.5-3.8	0.5-1.3	5.5	6000	580x380x630	45/50	
V-858D-05CB	# 9-11	3	5	364/356	4.4	0.5-3.8	0.5-1.3	5.5	5000	580x380x630	45/50	



Valuable Machine Accompany with you!



V-562E

INTERLOCK FLAT BED



Stitch sample

The machine is design for knitting material,with good quality spare parts to guarantee the stable sewing.

V-562E-01GB	# 9-11	3	5	364/356	4.4	0.5-3.8	0.5-1.3	5.5	6000	580x380x630	50/55	
V-562E-02BB	# 9-11	3	5	364/356	4.4	0.5-3.8	0.5-1.3	5.5	6000	580x380x630	50/55	
V-562E-05CB	# 9-11	3	5	364/356	4.4	0.5-3.8	0.5-1.3	5.5	5000	580x380x630	50/55	



Valuable Machine Accompany with you!



V-562AT-02BB

AUTOMATIC CUTTING BAND MACHINE



With electronic or pneumatic control knife system to cut the tap as you want.

V-562-05CBx364

ELASTIC LACE WITH RIGHT KNIFE



V-562Z-364

3 FUNCTION TOGETHER



							mm	S.p.m	mm	NW / GW Kg	
V-562D-01GB	# 9-11	3	5	364/356	4.4	0.5-3.8	0.5-1.3	5.5	6000	580x380x630	50/55
V-562D-02BB	# 9-11	3	5	364/356	4.4	0.5-3.8	0.5-1.3	5.5	6000	580x380x630	50/55
V-562D-05CB	# 9-11	3	5	364/356	4.4	0.5-3.8	0.5-1.3	5.5	5000	580x380x630	50/55



Valuable Machine Accompany with you!



V-664D-01GBx364/UT

INTERLOCK CYLIBDER BED



- 1) Cylinder bed for small part sewing such as collar, sleeve
- 2) With full function: Auto trimmer, presser foot lifter ,wiper, decoration line.
- 3) Can chose pneumatic and electronic
- 4) Also with simple direct drive type and conventional type

V-664-01GBx364-PL

INTERLOCK CYLINDER BED WITH PULLEY



Model	Thread #	Needle #	Foot #	Stitch #	Trimmer (mm)	Wiper (mm)	Presser foot lifter (mm)	Speed (S p.m)	Dimensions (mm)	Weight (kg)	
V-664-01GB	# 9-11	3	5	364/356	4.4	0.5-3.8	0.6-1.3	5.5	6000	580x380x630	45/50
V-664D-01GB	# 9-11	3	5	364/356	4.4	0.5-3.8	0.6-1.3	5.5	6000	580x380x630	45/50
V-664D-01GB/UT	# 9-11	3	5	364/356	4.4	0.5-3.8	0.6-1.3	5.5	6000	630x400x630	48/54
V-664D-01GB/UT-PL	# 9-11	3	5	364/356	4.4	0.5-3.8	0.6-1.3	5.5	5000	630x400x630	48/54



Valuable Machine Accompany with you!



V-664D-35ACx364/UT

INTERLOCK CYLINDER BED WITH LEFT TRIMMER

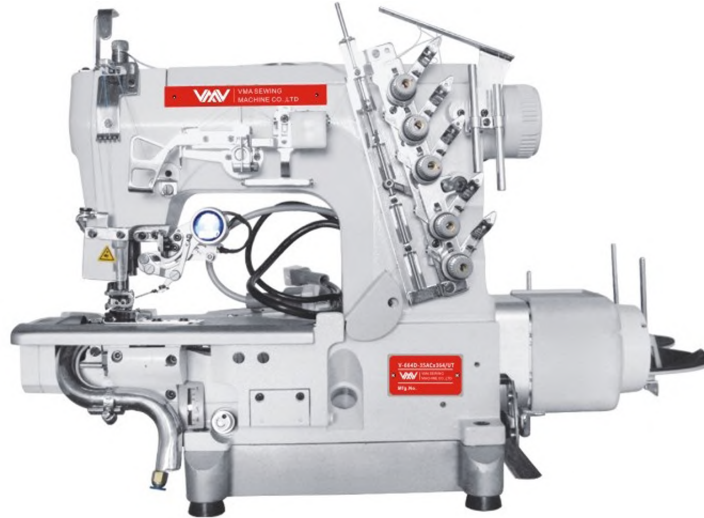

V-664D-33ABx364/UT

INTERLOCK CYLINDER BED WITH RIGHT KNIFE AND PULLEY FOR ELASTIC

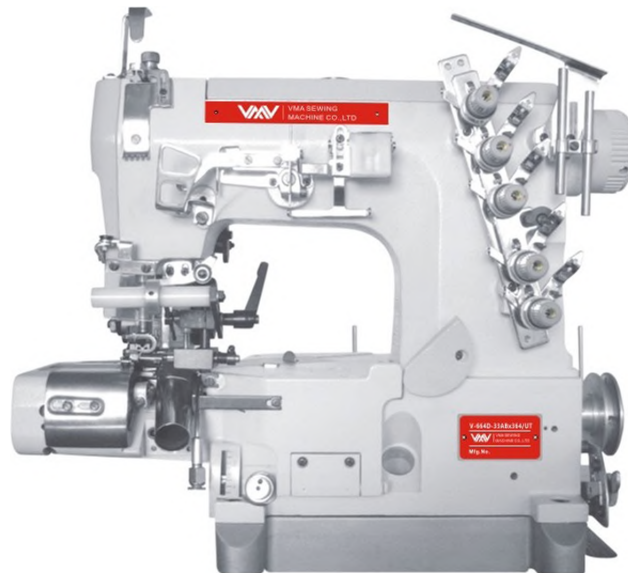

												NW / GW Kg
V-664D-35ACx364/UT	# 9-11	3	5	364/356	4.4	0.5-3.8	0.6-1.3	5.5	6000	630x400x630	48/54	
V-664D-33ABx364/UT	# 9-11	3	5	364/356	4.4	0.5-3.8	0.6-1.3	5.5	5000	630x400x630	48/54	



Valuable Machine Accompany with you!



V-80D

INTERLOCK NEW DESIGN



- 1) With double differential system, suitable for extremely thin material and heavy duty material, bottom hemming avoid shrink.
- 2) Newest feeding system make the stitch length from 0.5mm until 5.7mm (r)

V-80D-01GB/UT	# 9-11	3	5	364/356	4.4	0.5-3.8	0.6-1.3	5.5	6000	630x400x630	50/55	
V-80D-02BB/UT	# 9-11	3	5	364/356	4.4	0.5-3.8	0.6-1.3	5.5	6000	630x400x630	50/55	
V-80D-35AC/UT	# 9-11	3	5	364/356	4.4	0.5-3.8	0.6-1.3	5.5	5000	630x400x630	50/55	

V-7600D-01GCB/UT

INTERLOCK SMALLEST SEWING BED 178MM



V-7600D-01GB/UT	# 11-14	3	6	1/4"	1.4-3.6	12	3000	630x400x630	50/55	
V-7600D-01GB/UT-PL	# 19-21	4	8	1/4"	1.4-3.6	12	3000	630x400x630	50/55	



Valuable Machine Accompany with you!

SPECIAL SEWING MACHINE SERIES



VMA SEWING
MACHINE



Valuable Machine Accompany with you!



V-5878-58B

AUTOMATIC PLACKET SETTING MACHINE



- 1) Specially for T-Shirt placket setting, with 13 different series design
- 2) Machine head from original Japan
- 3) Control box Panasonic with very simple and easy system
- 4) Control panel easy to operate with English version.

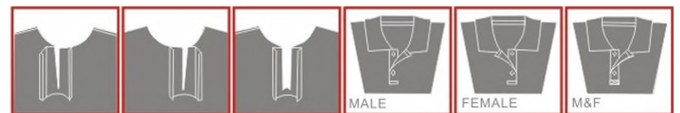

V-5878-58B	DP x 1 11#-14#	2	1-50	10-280	4000	2100x2000x1350	NW / GW Kg
							250/300



Valuable Machine Accompany with you!



V-12080D

PROGRAMMABLE ELECTRONIC LARGE AREA PATTERN SEWING MACHINE



Function characteristics:



EASY-OPERATION BIG SIZE COLOR LCD TOUCH OPERATION PANEL

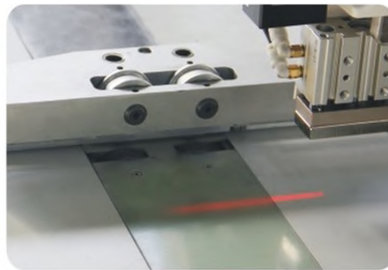

ONE-DIMENSIONAL TEMPLATE SCAN & IDENTIFY DEVICE

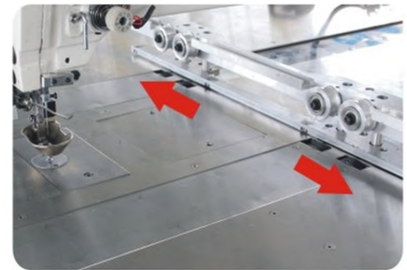

X-DIRECTION NO LIMIT



FLAT KNIFE THREAD CUTTING



BUILT-IN OIL LUBRICATION SYSTEM



EASY PROGRAMMING, USB FLASH DISC INPUT

V-3020/2210/1310

PATTERN SEWING MACHINE DIFFERENT AREA

- 1) DaHao or similar Brother control system
- 2) Japanese rail way guide, more stable for move
- 3) Encode motor with precise sewing
- 4) SMC pneumatic cylinder
- 5) Can chose Side move label attach mechanism
- 6) Middle small presser foot suitable for different height material

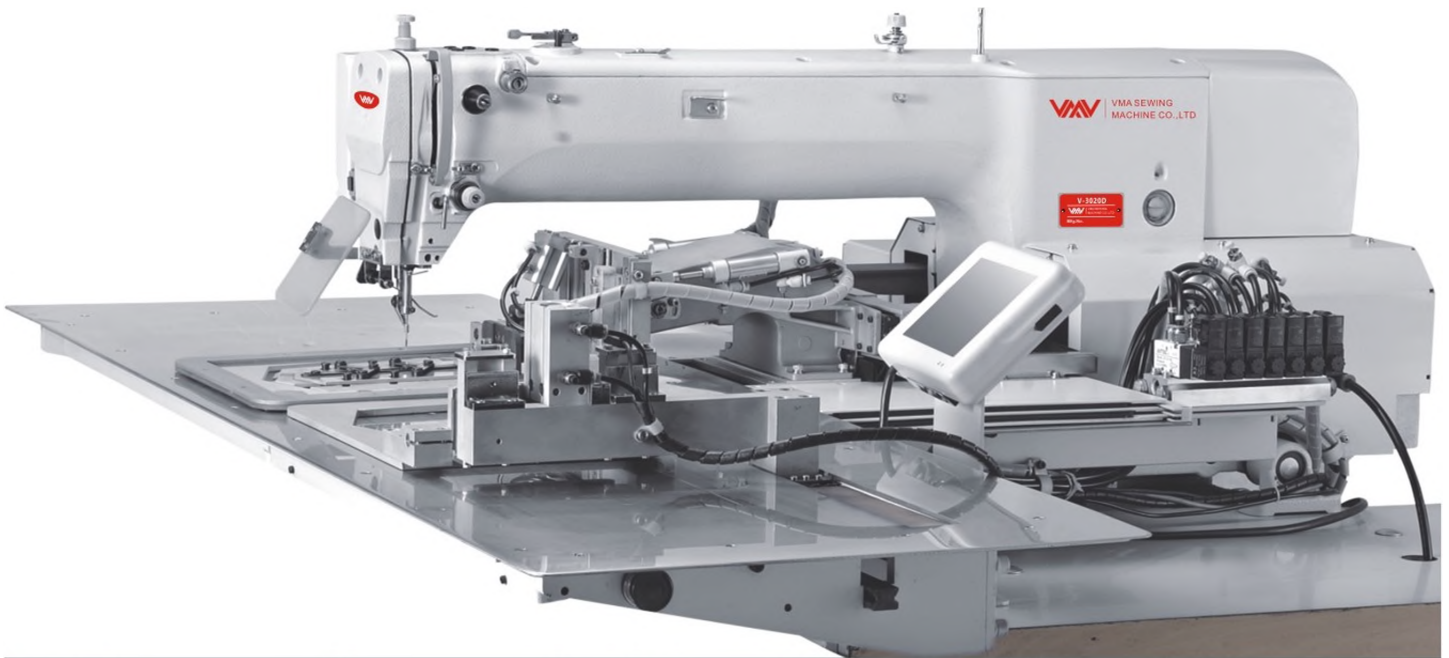

				X	Y	mm	S.p.m	mm	Kg
V-3020	DP × 5 16#	DP × 17 14#/19#/21#/24#	2	300 × 200	0.1-12.7(by0.1)	22	2700	1220x1220x1320	219/278
V-2210	DP × 5 16#	DP × 17 14#/19#/21#/24#	2	220 × 100	0.1-12.7(by0.1)	22	2700	1220x840x1320	139/183
V-1310	DP × 5 16#	DP × 17 14#/19#/21#/24#	2	130 × 100	0.1-12.7(by0.1)	22	2700	1220x840x1320	139/183



Valuable Machine Accompany with you!



V-430D

ELECTRONIC BAR TACKING



- 1) Can chose touchable screen optional choice;
- 2) Can us large area 40*30mm
- 3) Can change bar tacking to be button attach very easy

V-1906A

ELECTRONIC BAR TACKING



- 1) 60 × 40mm sewing area
- 2) DaHao touchable screen

	DP × 5	14#-16#	1	2	S.p.m	mm	mm	mm	mm	NW / GW Kg	
V-1900A	DP × 5	14#-16#	1	2	3000	40	30	15-150	14	806x375x740	45/57
V-1900AH	DP × 17	19#-21#	1	2	3000	40	30	15-150	14	806x375x740	45/57



Valuable Machine Accompany with you!



V-1790

ELECTRONIC BUTTON HOLING MACHINE



- 1) DaHao touchscreen easy to operate
- 2) With circulation sewing and sequence sewing improve efficiency
- 3) Can chose 120mm sewing area for Polo T-shirt button holings

V-9820

EYELET BUTTON HOLING MACHINE

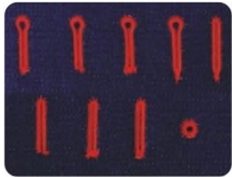

Stitch sample

- 1) Sewing speed 2500rpm
- 2) Large area to operate
- 3) Control panel easy to understand
- 4) High-precise stitch point sewing
- 5) With up-down trimmer system



V-9820	DO × 558 80-120	2	6-38	0.5-2	2500	1230x840x1420	140/160



Valuable Machine Accompany with you!



V-781D

DIRECT DRIVE BUTTON HOLING MACHINE



Presser foot feed system

- 1) DaHao touchscreen easy to operate
- 2) With circulation sewing and sequence sewing improve efficiency
- 3) Can chose 120mm sewing area for Polo T-shirt button holings

V-781D	DP × 5 11-14 #	1	1/4"	2	1	12	4	25X(2.5-4)	3600	700x340x905	NW / GW Kg
V-782D	DP × 5 11-14 #	1	1/4"	2	1	12	4	35X(2.5-5)	3600	700x340x905	62/75
V-783D	DP × 5 11-14 #	1	1/4"	2	1	12	4	41X(2.5-4)	3600	700x340x905	62/75



Valuable Machine Accompany with you!



V-1377D

DIRECT DRIVE BUTTON HOLING MACHINE

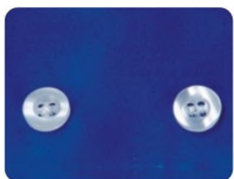

Stitch sample

- 1) Sewing speed 2500rpm
- 2) Large area to operate
- 3) Control panel easy to understand
- 4) High-precise stitch point sewing
- 5) With up-down trimmer system



			mm	mm	mm	mm				S.p.m	mm	NW / GW Kg
V-373-1	TQ × 1 TQ × 7	14-18 #	1	10-28	X(2.5-6.5) Y(0-6.5)	>9	○			1500	505x330x420	23/29
V-373-X	TQ × 1 TQ × 7	14-18 #	1	10-28	X(2.5-6.5) Y(0-6.5)	>9	○			1500	505x330x420	23/29
V-1377	TQ × 1 TQ × 7	14-18 #	1	10-28	X(2.5-6.5) Y(0-6.5)	>9	○			1500	505x330x420	23/29



Valuable Machine Accompany with you!



V-1850

BAR TACKING MECHANIC



Stitch sample



Beautiful stitch and stable sewing quality, with half hook good for heavy duty.

				mm	mm	mm	mm	S.p.m	mm	Kg	
V-1850	DP x 5	14-16 #	1	2	8-16	1.5-3	42	13	2000	770x370x610	42/56
V-1850H	DP x 17	19-21 #	1	2	8-16	1.5-3	42	13	2000	770x370x610	42/56

V-9280D-2PL

FEED OFF THE ARM DIRECT DRIVE MACHINE

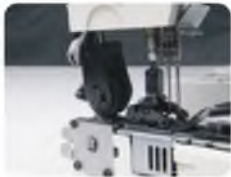

Double pulley



Stitch sample



- 1) V-9270 can chose 2 needle or 3 needles for thin material Shirts sewing cloth and so on
- 2) V-9280 with pulley specially for heavy duty such as Jeans and so on

				mm	mm	S.p.m	mm	mm		Kg	
V-9270-2PL	14 #	2	4	3.5	8	4000	3/16" 1/4" 1/8"	580x530x470		44/49	
V-9280XH-2PL	21 #	3	6	4.2	10	3600	3/16" 1/4" 1/8"	580x530x470		44/49	



Valuable Machine Accompany with you!



V-T20U53

ZIGZAG MACHINE

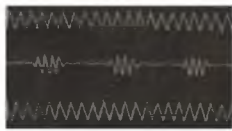

V-T20U43

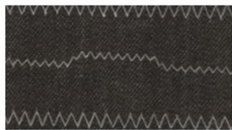

V-T20U53

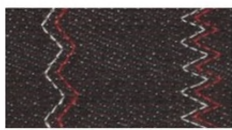

V-T457A



V-T20U53D panel



53D with 100 design



- 1) For thin/medium heavy duty material, shoes and caps, bags and leather.
- 2) Can choose 20U43 and 20U53, with different design.
- 3) Can choose 457A, one period sewing with 3 steps 4 points.
- 4) Can choose 20U93, which is automatic oil lubrication.
- 5) Can choose 20U53D, electronic one with 100 patterns available.

									NW / GW / Kg
	DP × 5		mm	mm	mm	S.p.m	w	mm	
V-T20U43	14-16 #	2	5	6-12	12	2000	250	560x260x445	20/28
V-T20U53	14-16 #	2	5	6-12	8	2000	250	560x260x445	20/28
V-T457A	14-16 #	2	5	6-9	8	1600	250	560x260x445	20/28
V-T20U53D	14-16 #	2	5	6-12	8	1800	250	560x260x445	20/28



Valuable Machine Accompany with you!



V-2284D-7/P

ELECTRONIC ZIGZAG MACHINE



Front



Reverse side

- 1) With design of 3 step zigzag stitch
- 2) With auto-trimmer and presser foot lifter function



										NW/GW Kg
					mm	mm	mm	S.p.m	mm	
V-2284-D					10	5.5-10		4500	660x350x620	39/47
V-2284-D-7			*	*	10	5.5-10		4500	660x350x620	39/47
V-2284-D-7/P			*	*	10	5.5-10	*	4500	660x350x620	39/47

V-2290SR-7

COMPUTERIZE ZIGZAG MACHINE



- 1) Machine with 200 designs inner side
- 2) Step motor control the feed mechanism, quickly and stable;
- 3) Touch screen easy to operate and can make design as you need.

Name of pattern	Straight stitch	Basic zigzag	2 step zigzag	3 step zigzag	Scallop(left)				Scallop(right)				Blind stitch (left)	Blind stitch (right)	Custom pattern
					Standard	Crescent	Equal-width	Equal-width	Standard	Crescent	Equal-width	Equal-width			
Stitch patterns															
Number of stitch	1	2	4	6	24		12		24		12		2+α	maximum 500	

V-6200D

4 NEEDLES 6 THREAD MACHINE WITH AUTO-TRIMMER

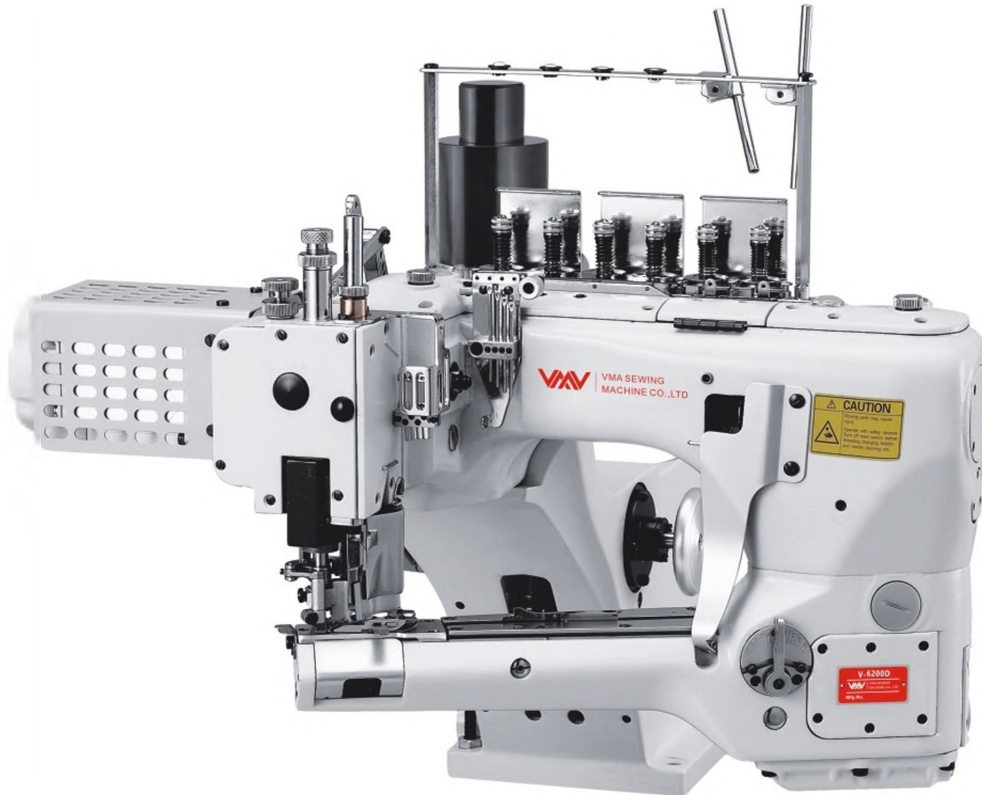

- 1) Fully oil-sealed design, without oil pollution
- 2) For various materials, such as single jersey to fleece, stretchable and uneven thickness portion, overlapping amount of upper/lower fabric ect.
- 3) 148mm cylinder bed , 200mm length sewing bed, suitable for widely operation.
- 4) Easy to adjust the differential ration by outer lever
- 5) Thread tension can be adjusted individually for neat stitch formation.

			mm	mm	mm	A430	A430	S.p.m	mm	NW / GW Kg
V-6200D-01MR-5.2/6.0-D(-7)	Knitting	GBX118 11#	6	5.2/6.0	1.6-2.5	30	★	6	4000	590x390x490 23/31
V-6200D-01MS-5.2/6.0-D(-7)	Knitting	GBX118 11#	6	5.2/6.0	1.6-2.5	30	★	6	4000	590x390x490 23/31
V-6200D-02MR-5.2/6.0-D(-7)	Sportswear	GBX118 11#	6	5.2/6.0	1.6-2.5	30	★	6	4000	590x390x490 23/31
V-6200D-02MS-5.2/6.0-D(-7)	Sportswear	GBX118 11#	6	5.2/6.0	1.6-2.5	30	★	6	4000	590x390x490 23/31
V-6200D-03MR-5.2/6.0-D(-7)	Sock	GBX118 11#	6	5.2/6.0	1.6-2.5	30	★	6	4000	590x390x490 23/31
V-6200D-03MS-5.2/6.0-D(-7)	Sock	GBX118 11#	6	5.2/6.0	1.6-2.5	30	★	6	4000	590x390x490 23/31
V-6200D-04MR-5.2/6.0-D(-7)	Thermal underwear	GBX118 11#	6	5.2/6.0	1.6-2.5	30	★	6	4000	590x390x490 23/31
V-6200D-04MS-5.2/6.0-D(-7)	Thermal underwear	GBX118 11#	6	5.2/6.0	1.6-2.5	30	★	6	4000	590x390x490 23/31
V-6200D-05MR-5.2/6.0-D(-7)	Diving suit	GBX118 11#	6	5.2/6.0	1.6-2.5	30	★	6	4000	590x390x490 23/31



Valuable Machine Accompany with you!



V-T500

BLIND STITCH MACHINE DOMESTIC



V-T511

BLIND STITCH MACHINE INDUSTRIAL



V-T641-2A

BLIND STITCH FLAT HEAD



V-T641-6B

BLIND STITCH CYLINDER BED



V-T641E

ELECTRONIC WITH TRIMMER



Manual lubrication, for common cloth, sweater, hats etc.

Auto lubrication, for gloves, socks etc.



V-T500



LW×6T 11-14#



1:1



1:2



5



7



S.p.m

1200



395x355x330



NW / GW Kg

11/14



Valuable Machine Accompany with you!



V-6000D

IMITATION BUTTON HOLING MACHINE



- 1) LED screen, direct drive motor
- 2) Length of stitch, size of imitation hole could adjust on control panel
- 3) The quantity of imitation holes and distance between imitation holes adjust in control panel

V-63900

AUTOMATIC TROUSERS HEMMING MACHINE



- 1) With double pulley top and bottom feed
- 2) 12.7mm width, 200mm round sewing bed
- 3) Suitable for suit trousers, jeans, working uniform pants
- 4) With auto-timmer/ presser foot lifter/ split & close hemmer.
- 5) V-63900L is lockstitch mechanism, V-63900C is chain stitch mechanism

V-63900	DV × 5/7 #15-23#	1	2	14 mm	3500 S.p.m	580x530x470 mm	NW / GW Kg
							44/49



Valuable Machine Accompany with you!



V-T588

SUPER HAND STITCH SEWING MACHINE

- 1) With half stitch button to short the rest length of thread
- 2) Freely change the length of pin-point and stitch length, also the length of top and bottom thread can keep even.
- 3) With positioning device to make sewing more easy
- 4) With thread tension adjust device



V-T588	780C 16-23 #	1	90 mm	0.5-6 mm	8 mm	S.p.m	mm	NW / GW Kg
						420-500	1280x960x860	191/225

V-T388

HAND STITCH SEWING MACHINE

- 1) Single needle chain stitch machine, the stitch is similar with hand-made type.
- 2) Suitable for produce suit, western style trousers, woman overcoat and fashion dress, etc.

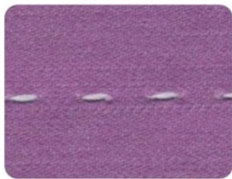

Stitch sample



V-T388	DPX5 16-20 #	1	5-8 mm	2,3,4,5 mm	6-10 mm	S.p.m	mm	NW / GW Kg
						1000	590x230x550	29.5/36.5



Valuable Machine Accompany with you!



V-T818E

BUTTON ATTACH MACHINE ELECTRONIC

Can be 3 heads



V-T818P

BUTTON ATTACH MACHINE PNEUMATIC



V-T818

BIG BUTTON MACHINE

- 1) Suitable for big special buttons attach, such as rivets of jeans, leisure wears, boxes, bags and so on.
- 2) With double protection device, stable and could match the customers' demands.



V-T818	34	300	250	220/380	365x330x530	NW / GW Kg
						22.5/24.8



Valuable Machine Accompany with you!



V-T26-1A / V-GK-9

BAG CLOSER MACHINE



Suitable for leather bag, flax cloth and plastic-woven bag and so on.

	mm			S.p.m		mm	NW / GW Kg
V-T26-1A	6.5	1	DNX1 25 #	1250	110V/220V	400x270x370	5.6/8.0
V-GK-9	7.5	1	25 # 800		220V	330x270x160	4.5/6.0

V-T20S

DESKTOP THREAD DISTRIBUTOR MACHINE



V-T38

SHELL STITCH OVERLOCK MACHINE



V-T109

CARPET OVERLOCK SEWING MACHINE





Valuable Machine Accompany with you!



DOMESTIC MACHINES

V-DO30

FEATURING 30 BUILT-IN BASIC STITCHES WITH DIGITAL DISPLAY



V-DO16

FEATURING 16 STITCHES DOUBLE THREAD,DOUBLE SPEED



V-DO12

FEATURING 12 STITCHES DOUBLE THREAD,DOUBLE SPEED



V-DO08

FEATURING 8 STICHES DOUBLE THREAD,DOUBLE SPEED



V-DOMINI-208

MINI SEWING MACHINE



V-DOMINI-203

MINI SEWING MACHINE





Valuable Machine Accompany with you!



V-1412ATE

CYLINDER BED AUTOMATIC MULTI-NEEDLE MACHINE

- 1) Servo motor with full function
- 2) Trimmer and blow the thread system, improve 20% efficiency and save 25% thread
- 3) Easy to adjust the stitch length
- 4) Cylinder bed 420mm round, match with expand device for trousers waist open
- 5) 13 needles with freely gauge set, match different request



Directdrive serve motor:stable, reliable,with automatic needle set,automatic under trimmer and thread blow out,etc,Comparing with cluth motor,it can save electricity by 30%-40%.



This is the automatic thread blow by air system



With automatic under trimmer and thread blow out by air,it can improve work efficiency more than 20%,also can reduce quantity of thread used by 25%.



Cylinder-bed design,its out perimeter is 420mm,with elastic band tensioner system,it can improve work efficiency easily.



This is the push bulton,convenient for you to adjust gauge size.



13 needle machine with freely gauge set,it can make different gauge size according to custome's request.



Valuable Machine Accompany with you!



V-1404D

4-NEEDLE FLAT-BED MULTI-NEEDLE MACHINE

SELECTED MACHINE MODEL AND NEED GAUGE

- V-1406P, V-1406PL: 1/4X6N, 5/16X6N, 3/8X6N
- V-1408P, V-1408PL: 1/4X8N, 5/16X8N, 3/8X8N
- V-1412P, V-1012PS
- V-1412PL, V-1412PS-ET: 1/8X12N, 3/16X12N, 1/4X12N
- V-1413P: 1/8X13N, 3/16X13N, 1/4X13N, 1/4-1/8-1/8-1/4-1/4-1/8.....
- V-1417P, V-1017PS
- V-1417PS-ET: 3/16X17N
- V-1423P: 1/8X23N



- 1) Subclass: MR: machine with willing device WB: machine for attaching waistbands
- 2) PSF: machine for shirt fronting PSM: machine for smocking
- 3) PSSM: machine for simultaneous shirring+smocking ET: looper thread elastic model
- 4) PSET: machine with shirring (needle: polyester thread, looper: elastic thread)
- 5) PQ: machine with shirring (needle: polyester thread, looper: polyester thread, elastic thread: threading on surface of needle plate.)
- 6) PL: machine for attaching line tapes
- 7) Option: MD-1: metering device



V-1404PSF
4-needle flat-bed sewing machine for shirt fronting



V-1406P
4-needle flat-bed sewing machine device for attaching elastic band



V-1406PL
6-needle flat-bed double chain stitch sewing machine



V-1408P
6-needle flat-bed double chain stitch sewing machine



V-1404PMD
8-needle flat-bed double chain stitch sewing machine

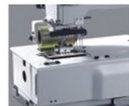

V-1412P
12-needle platform-bed double chain stitch chain sewing machine

V-1404P	4	8	3/4, 1-1/8, 1-1/4, 1-1/2, 1/4-2/1/4	1.8-4.3	10	UOX113 14UYX113 90	4000	0148	48/44
V-1404PSF	4	8	3/4, 1-1/8, 1-1/4, 1-1/2, 1/4-2/1/4	1.8-4.3	10	UOX113 14UYX113 90	4000	0148	48/44
V-1404PMD	8	16	1/4 3/16	1.8-4.3	10	UOX113 14UYX113 90	4000	0148	57/53
V-1406P	6	12	3/16 1/4 5/16 1/3 3/8	1.8-4.3	10	UOX113 14UYX113 90	4000	0148	50/46
V-1406PL	6	12	3/16 1/4 5/16 1/3 3/8	1.8-4.3	10	UOX113 14UYX113 90	4000	0148	50/46
V-1408P	8	16	3/16 1/4 5/16 3/8	1.8-4.3	10	UOX113 14UYX113 90	4000	0148	57/53



Valuable Machine Accompany with you!



V-008VCD

MULTI-NEEDLE CYLINDER BED

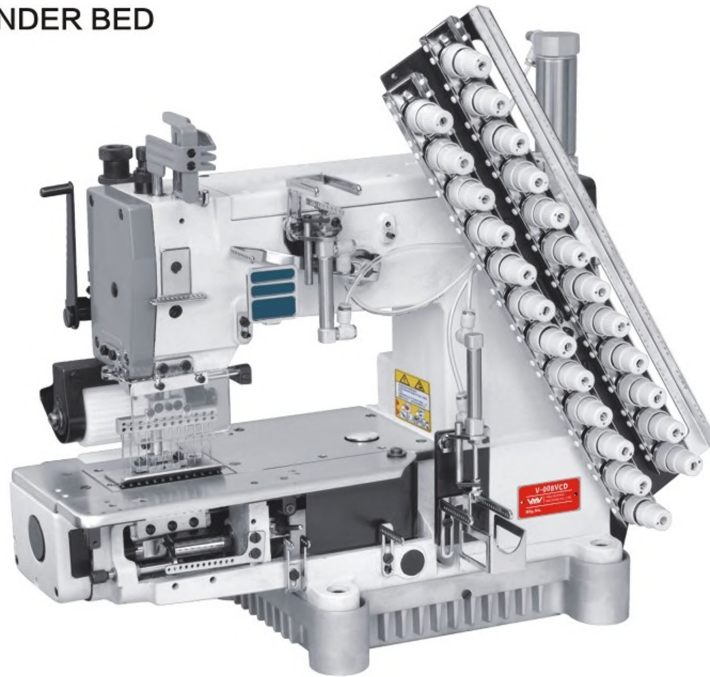

Cylinder bed automatic oil lubrication, back and forth looper driving mechanism.



V-008VC-04085P/VCE/VWLB/VSF
4-pin half-cylinder-bed double chain-stitch machine



V-008VC-08064/VPL
8 needle half cylinder type used for tape attaching
Double chain stitch machine



V-008VC-12064P/VPS
12 needles



V-008VC-12064P/VPT
12-needle half cylinder type Back and forth
driving double chain stitch machine



V-008VC-13032P
13 needle optional needle position for general sewing



V-008VC-17048P
17 needles

			mm	mm	AUTO		S.p.m	mm	NW / GW Kg
V-008VC-04064P	4	8	1/4"5/16"1/4"-1"-1/4"	1.4-3.6	12	11 # - 14 #	4500	600 × 400 × 600	48/52
V-008VC-06064P	6	12	1/4"3/16"	1.4-3.6	12	11 # - 14 #	4500	600 × 400 × 600	48/52
V-008VC-08064P	8	16	1/4"3/16"	1.4-3.6	12	11 # - 14 #	4500	600 × 400 × 600	48/52
V-008VC-12064P	12	24	1/4"3/16"	1.4-3.6	12	11 # - 14 #	4500	600 × 400 × 600	48/52
V-008VC-13032P	13	24	1/4"1/8"	1.4-3.6	12	11 # - 14 #	4500	600 × 400 × 600	48/52
V-008VC-17048P	17	24	3/16"	1.4-3.6	12	11 # - 14 #	4500	600 × 400 × 600	48/52
V-008VC-21032P	21	24	1/8"	1.4-3.6	12	11 # - 14 #	4500	600 × 400 × 600	48/52
V-008VC-23032P	23	24	1/8"	1.4-3.6	12	11 # - 14 #	4500	600 × 400 × 600	48/52



Valuable Machine Accompany with you!



V-13024WD

2-NEEDLE PICOT AND FACOT SEWING MACHINE FOR ACHIEVING WISHFUL DESIGN



V-1508PD

1-4 NEEDLE FLAT-BED WITH HORIZONTAL LOOPER MOVEMENT MECHANISM



V-82000D

BELT LOOPER MACHINE



V-1433PSM

33-NEEDLE FLAT-BED SEWING MACHINE WITH SHIRRING





Valuable Machine Accompany with you!



V-69910E

ELECTRONIC POST BED MACHINE



- 1) Electronic with trimmer function, reverse sewing, half stitch;
- 2) Control box powerful and very stable
- 3) Triple transport for strong sewing
- 4) Bering design more durable and stable
- 5) Suitable for riding boot, gym shoes, leisure shoes, sponge shoes, baby shoes, high class leather shoes and all kinds of cases.

V-69910D

DIRECT DRIVE POST BED MACHINE



V-69910

POST BED MACHINE BIG HOOK SMALL HAND WHEEL



V-69920

POST BED MACHINE DOUBLE NEEDLE



V-69910	DPX5 17-23 #	2	0-7 mm	7 mm	S.p.m	mm	NW / GW Kg
V-69920	DPX5 17-23 #	4	0-5.5	7	2500	625x320x640	54/58



Valuable Machine Accompany with you!



V-68810

ROUND BODY POST BED MACHINE



V-68910

SQUARE BODY POST BED MACHINE



V-68365

SUPER HIGH POST BED MACHINE
COMPOUND FEED











V-68760

REACH TO 700MM HEIGHT,
WITH 3 TIMES BIGGER HOOK



- 1) Compound feed suitable for many layers heavy duty sewing
- 2) Specially for luggage case sewing, high leather shoes sewing, gym bags and so on
- 3) The height has many different size to match customer's demands

			 mm	 S.p.m		 mm	 NW / GW Kg
V-68810	DPX5 19-22 #	2	6	3000	/	640x270x575	35/39
V-68820	DPX5 19-22 #	4	6	3000	2.4 / 3.2 / 4.0	640x270x575	35/39



Valuable Machine Accompany with you!



V-62681







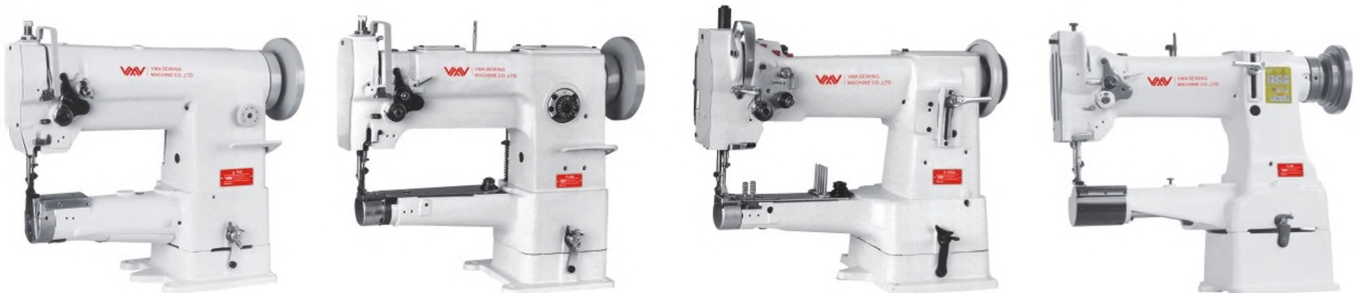

CYLINDER BED TRIPLE TRANSPORT SEWING MACHINE AUTO LUBRICATION



- 1) Feed dog, presser foot, and needle feeding together.
- 2) Automatic lubrication system
- 3) V-62681 and V-62681-LG are horizontal hook system, suitable for binding stitch
- 4) V-62682 and V-62682-LG series are oval-shaped hook system, suitable for common sewing
- 5) LG means large hook

V-341 V-246 V-335A V-8B



			 mm	 mm	 S.p.m	 mm	 NW / GW Kg
V-62681	DPX17 18-24 #	2	0-5	6-15	2000	580x250x530	25.5/32.5
V-62682	DPX17 18-24 #	2	0-5	6-15	2000	580x250x530	25.5/32.5
V-62682-LG	DPX17 18-24 #	2	0-5	6-15	2000	580x250x530	25.5/32.5



Valuable Machine Accompany with you!



DOUBLE TRANSPORT MACHINE

V-0303D



V-0303



V-0302



V-0311E



V-0302	DP x 17 18-24#	2	0-8 mm	6-13 mm	2000 S.p.m	580 x 250 x 530 mm	NW / GW Kg 25.5/32.5



Valuable Machine Accompany with you!



V-6668

HEAVY DUTY TRIPLE TRANSPORT MACHINE



- 1) Feed dog, presser foot, and needle feeding together.
- 2) With wider presser foot lifter and longer stitch length which around 10mm.
- 3) Suitable for bags, luggage cases, sofa cushions, boxing gloves, leather products, etc.

V-5942

HEAVY DUTY TRIPLE TRANSPORT MACHINE (TOP QUALITY)



- 1) Feed dog, presser foot, and needle feeding together.
- 2) With over-duty safety device to protect the hook and gear.
- 3) Machine is more stable and durable, sewing is quite.
- 4) V-5942-1 is single needle
- 5) V-5942-2 is double needle
- 6) Suitable for cushions, safety belts, safety air bags, tents, parachutes, etc.

V-60698

LONG ARM TRIPLE TRANSPORT MACHINE



Stitch sample



- 1) Operate space reach to 635mm
- 2) For large work pieces such as covers of the car, safety belts, tents, parachutes, sails and so on.
- 3) V-60698-2 is double needle

			 mm	 mm	 S.p.m	 mm	 NW / GW Kg
V-6658	DPX17 22-24 #	2	0-10	8-14	2000	580x250x530	25.5/32.5
V-6668	DPX17 22-24 #	2	0-10	8-14	2000	580x250x530	25.5/32.5
V-5942-1	DPX17 8-23 #	2	3-9	8-16	2000	670x350x365	40.5/47.5
V-5942-2	DPX17 8-23 #	4	3-9	8-16	2000	670x350x365	40.5/47.5
V-60698-1	DPX17 18-23 #	2	3-9	8-16	1800	1300x570x280	90/99
V-60698-2	DPX17 18-23 #	4	3-9	8-16	1800	1300x570x280	90/99

V-2792

SHOES REPAIR MACHINE



- 1) Can attach clutch motor, max speed 500RPM;
- 2) Presser foot lifter 15mm; needle DPx17 Dlx3, max. Stitch length 10mm.
- 3) Can 360 degree turn on the shoes during sewing, small cylinder bed, with the width no more than 28mm.
- 4) Can sewing the small and special materials which with small angle.

V-168

DOUBLE THREAD SLOCK STITCH SEATED TYPE SHOE-BORDER STITCHER



Size S, M, L are available, from kids' shoes to snow boots.

V-T801

ROUND KNIFE SHAPING MACHINE



Stitch sample

- 1) With knife grinder which makes the sharp all the time
- 2) With automatic bits removing
- 3) Round shape bearing makes it working smoothly and with low noise
- 4) Suitable for shoes, leather, handbags and gloves.



V-T801



S.p.m

1200



370/250



mm

635x425x420



NW / GW

Kg

40/44



Valuable Machine Accompany with you!



V-4-5

FUR SEWING MACHINE



V-4-6A

FUR SEWING MACHINE



V-2610F-SM

FUR SEWING MACHINE



V-600

HEAVY DUTY LUBRICATION
OVER-SEAMING MACHINE



V-6003

HEAVY DUTY LUBRICATION
OVER-SEAMING MACHINE



V-800-1

HEAVY DUTY LUBRICATION
OVER-SEAMING MACHINE





Valuable Machine Accompany with you!



V-207

INNERSIDE TRIMMING MACHINE

Outsole digging trimmer is specialized in the repair process cut uppers and rubber soles, no pattern of holes aside, Burr groove shape within small 5mm hole, ditch are very clean and repair will not hurt to the upper, the sole body. Allows you to use it quick and easy, improve efficiency, reduce Low cost of production. It is a good partner during the trimming work.



V-903

INNERSIDE TRIMMING MACHINE



V-902

INNERSIDE TRIMMING MACHINE



V-206

INNERSIDE TRIMMING MACHINE



V-202Z

INNERSIDE TRIMMING MACHINE



V-25

SEAM OPENING AND TAPE ATTACHING MACHINE



Convenient to use, easy to operate and good for shaping. upper wheel teamed lower wheel feed materials that can increase cohesion between leathers or clothes, high foundation with wide application scope. it is suitable for gluing and shape modifying of all kinds of heelpieces.



Valuable Machine Accompany with you!









V-T801A

CUTTING CLOTH STRAP MACHINE



- 1) For knitting clothes cutting and bundle, the width can be adjusted to 100mm.
- 2) Can choose single knife or double knife. V-T802A is double knife.

		 mm	 S.p.m		 mm	 NW/GW Kg
V-T801A	1	16-51	1400	110V/220V	820x340x250	20.5/23.5
V-T802A	2	16-51	1400	110V/220V	820x340x250	20.5/23.5

V-T911

BIG CUTTING CLOTH STRAP MACHINE



- 1) Use for more cutting demands factories
- 2) Cutting width 15-90mm
- 3) V-T933 for elastic material

V-803AT

AUTOMATIC CUTTING CLOTH STRAP MACHINE



- 1) LCD screen can chose the cutting cloth length
- 2) With emergency stop button
- 3) Use Spring press the blade, to improve the blade using time
- 4) Adopt steeples speed system, which is more suitable for elastic and round roll material
- 5) Bearing and chains transport, more stable and quite
- 6) With 3-5 knives, more efficiency
- 7) The cloth folding passing device easy to adjust the cloth angle
- 8) Spreading and winding system can adjust automatic according to the cloth width
- 9) The winding sleeve use the bearing, which is more smoothly
- 10) The bottom base easy to change the angle and move.



Valuable Machine Accompany with you!



V-BK900

BAND KNIFE



- 1) Cutting speed with 3 different level, also have option for stepless speed adjust
- 2) Attach with a special air-floated blowing device to reduce the extra resistance between cutting material and cutting table
- 3) Easy to change the cutting blad
- 4) With grinding device to keep the blade sharp
- 5) With belt broken protection device

V-BK1200

BAND KNIFE



Model	Cutting height	Bonding pressure	Cutting motor power	Linear velocity of tool	Weight	Dimension
V-BK700	180mm	12kpa	750w	11.0; 12.2; 13.3m/min	247kg	1530 × 760 × 1750mm
V-BK900	180mm	12kpa	750w	11.0; 12.2; 13.3m/min	276kg	1880 × 760 × 1750mm
V-BK1200	200mm	15kpa	750w	11.0; 12.2; 13.3m/min	338kg	2500 × 760 × 1750mm



Valuable Machine Accompany with you!



V-T3 / V-T103

STRAIGHT KNIFE CUTTING MACHINE



- 1) V-T3 With 550W and 750W, can chose 6inch, 8inch, 10inch, 12inch
- 2) V-T3A Cutting machine black one prevent static electricity, prevent flash shirring
- 3) V-T3-15" Special for heavy cutting With 1200W 12inchd and 15inch
- 4) V-T103 KM type
- 5) V-T108 Cutting machine 5 inch
- 6) V-T103D Cutting machine with servo motor



	mm	S.p.m	V	hz	mm	NW / GW Kg	
V-T3	110 160 210 260	2800/3450	550/750	110V/220V	50/60	720x390x300	15/18



Valuable Machine Accompany with you!



V-T125D

SMALL RUOND KNIFE WITH SERVO MOTOR



Cutting machine with servo motor and led light, orange & blue & purple color

V-T110

SMALL ROUND KNIFE



V-T100

SMALL ROUND KNIFE



V-T90

SMALL ROUND KNIFE



V-T70

SMALL ROUND KNIFE



V-T65

SMALL ROUND KNIFE



V-TDB3

AUTOMATIC END CUTTER MACHINE



- 1) V-TDB2 Semi-automatic end cutter machine
- 2) V-TDB1 Manual end cutter machine

	S.p.m					mm	NW / GW Kg
V-TDB-3	12000	1.6 1.8 2.2 2.4	2.1 2.3 2.5 2.7 2.9 3.1	200	110V/220V	760x430x320	58/63
V-TDB-1	12000	1.6 1.8 2.2 2.4	2.2 2.4 2.6 2.8 3.1	160	110V/220V	760x460x190	15/18

V-110LR / 120HL

BELT LOOP CUTTER



Economic hot knife cutter



Economic Belt loop cutter (cold & hot)

- 1) High speed: It can cut 70-90 pcs per minute. (50mm long)
- 2) Accuracy: Cut-length is accurate with stepping motor
- 3) Cutting type: Melting & cutting by hot knife, woven label is cut neatly without fraying but not for heavy materials and installed with anti-static electricity device
- 4) Automatic operation: It works automatically only by setting length and quantity
- 5) Automatic stopper: It stops automatically if materials run out during operation

Model	Cutting Length mm	Max.Cutting Width mm	Cutting Speed P/min	Max.Blade Temp °C	Voltage V	Frequency Hz	Power kw	Package Size L.W.H mm	Weight kg	Loading Rate Pic
V-110H	20-9999	100	120	420	100/220	50/60	0.66	560X420X405	24/29	1
V-110LR	20-999	95	90	300	110/220	50/60	0.66	560x420x405	24/29	1



Valuable Machine Accompany with you!



V-F450(500/600)-B

AUTOMATIC BELT WARPING PREVENTION FUSING MACHINE



1) Hot melt adhesive pressurized continuous bonders, it has to prevent migraine with special properties suitable for fabric and fusible interlining of thermo-compression bonding purposes. It can be widely used in various non-flammable agents contain fabric collar, chest, cuffs, placket, cuffs, waist top fabric and adhesive products smooth suiff and resistant to washing, easy trend, the dragon it applicable to all resins collar lining, non-woven adhesive liner.

2) B type is have limit switch, atuomatic belt warping prevention by motor.

3) C type is in the non rotating driven wheel (inlet position) add in limit plate, in order to achieve the purpose of adhesive tape

V-1600-QS2

FUSING MACHINE BIG SIZE



1) Feeder features: the ability to correct two rolls of material fed to the pressure lining machine.

2) Pressure lining machine function: pressing the merger will roll feeder or feeder side sent.

3) Rewinding machine features: The fabric after lamination roll harvest.

4) Control Center functions: control of three parts, monitoring, information display.



Valuable Machine Accompany with you!



PRINTING MACHINE



V-38×38



V-38×62



V-38×82

- 1) Intelligent digital control temperature achieve the high precision(± 2 degree),which is safety,durable and heat teperature distribute uniform.
- 2) Electronic time control,after finish process machine will shows signal mention the workers.
- 3) The random adjustment for the pressure
- 4) The bottom plate with the silica gel,could prevent the high temperature,which reach to 200 degree.

V-60×80



V-4060S1

AUTOMATIC PNEUMATIC TRANSFER PRINTING MACHINE



- 1) One person can operate 2 working positions
- 2) Production capacity:the normal yield 350~400/h
- 3) The efficiency is improved by 45%



Valuable Machine Accompany with you!



V-TDZ-B1

VACUUM IRONING TABLE



- 1) The net shelf is made of stainless steel, rustless and more longer life.
- 2) Holey sponge, good of quality and ventilate strong suck-wind.
- 3) The noise lower than commonly product, easily operate.
- 4) All series can add-ons; Electric tubes, Vacuum outlet, Hanger, You can choice between vacuum and blowing function.
- 5) Suitable for various kind of garment and washing industry.

V-TDZ-B7

VACUUM IRONING TABLE





Valuable Machine Accompany with you!



V-DLD6~12-0.4-F1

FULLY AUTOMATIC ELECTRICALLY- HEATED STEAM BOILER (TOP TECHNOLOGY)

- 1) Advanced, safe high intelligence can, cutting-edge technology to produce the most safe and ideal steam boilers with tank and high pressure feed water pump.
- 2) Automatic low water level control devices, safety valve, pressure controller, water table, durable heating pipes, each furnace inspected welds are X ray, reliable quality.
- 3) Equipped with the latest development of a heat exchanger, the exhaust steam recycling, the thermal efficiency has greatly improved, to achieve energy saving effect, on the market latest generation of energy-saving products.



V-DLD3-0.4-A1 (SMALL ONES)

ELECTRICALLY-HEATED STEAM BOILER

- 1) It manufactures the most safe and ideal steam boilers with the advanced, top security technology with high performance.
- 2) It is attached with water tank, high pressure pump, fully automatic high & low water level cut-off device, relief valve, pressure controller, the durable achorific wire for water level gauge, each boiler welding seam has passed X-ray check. It proves to have reliable quality after the examination.





Valuable Machine Accompany with you!



V-SP801

PRESS MACHINE



V-SP801E

PRESS MACHINE



V-SP801T

PRESS MACHINE



V-SP8801

PRESS MACHINE



V-6PC



V-B-200



V-520



V-SP610



PLOTTER MACHINES

V-ST1800PHQ V-ST1200PHQ PLITTER CUTTING MACHINE



V-ST1800 V-ST2200



Model	V-S1800
Usable Graph Width	180cm
Driver	digital high-speed servo control with a whole closed loop location
Jet Nozzle	forward direction and reverse direction jet nozzle (model HP45)
Resolution	150DPI-600DPI (ink-saving mode optional)
Speed	Bi-direction $\leq 80\text{m}^2/\text{h}$
Communication Port	Serial Port、USB Output
Software Platform	Windows98、2000、NT、XP
Power Supply	110-220V 50-60Hz
Paper	Normal CAD marker paper 40-120G
Cleaning Ink Gun	automatic cleaning capacity
Operation and Display	Large LCD screen, off-line independent operation
Paper Supply System	Pre-positive paper collection, invisible infrared control system

LASER CUTTING MACHINE



V-LS9060



V-LS1610AF
AUTO FEEDING LASER CUTTING MACHINE

Model	S6040	S9060	S1080	S1390	S1610
Processing Area	600x400mm	900x600mm	1000x800mm	1300x900mm	1600x1000mm
Laser Type	Sealed CO2 Laser Tube				
Laser Power	60w/80w/100w/130w/150w				
Cutting Speed	0-500mm/s				
Engraving Speed	0-1000mm/s				
Motion System	DSP Controller, Three Phase Stepping Motor, Motor Driver				
Location Precision	0.01mm				
Smallest Shapingcharacter	English: 1x1mm Letter, Chinese: 2x2mm				
Supported Graphic Format	PLT,DXF,AI,DST,BMP,TIF,PNG,JPG				
Supported Software	AutoCAD, CorelDRAW, Photoshop				
Cooling System	Water Chiller				
Power Supply	AC110, AC220V, 50HZ/60HZ				
Working Environment	Temperature:0-40degree; Humidity: 5-80% (no Condensate Water)				



Valuable Machine Accompany with you!



V-1201/1202

EMBROIDERY MACHINE

Features

- 1) Maximum speed 1000RPM
- 2) Memory size 2000000 stitches
- 3) Memory format:read files in Tajima and Barudan
- 4) Electricity:110V/60HZ OR 220V/50HZ
- 5) Automatic:trimming
- 6) Automatic color changing
- 7) Automatic thread breacking detecting
- 8) Touch computer control system
- 9) Imported Hook and Belt
- 10) Internet cable,usb driver
- 11) Built-in bobbin winder

Hoops/frames Included

- 1) 2xShirt Round Hoop 9 cm
- 2) 2xShirt Front Round Hoop 12 cm
- 3) 2xShirt Front Round Hoop 15 cm
- 4) 2xShirt Front Round Hoop 22 cm
- 5) 2xJacket Back Square Hoop 29 x 29 cm
- 6) 1xJacket Back Square Hoop 37 x 51 cm

Cap Attachment Included

- 1) 2 x cap frames
- 2) 1 x cap driver
- 3) 1 x drive of cap frame every machine



Needles	Head	Embroidery Space(lxw)	Length	Width	Height	Weight
12	1	370x510(mm)	800(mm)	800(mm)	1600(mm)	150(kg)
15	1	370 x 510(mm)	800(mm)	800(mm)	1600(mm)	150(kg)



Valuable Machine Accompany with you!



EMBROIDERY MACHINE

V-906

Features

- 1) Maximum speed 850RPM
- 2) Memory size 2000000 stitches
- 3) Memory format:read files in Tajima and Barudan
- 4) Electricity:220V/50HZ OR 380V/50HZ
- 5) Motor:Panasonic servo
- 6) Automatic trimming
- 7) Automatic coloe changing
- 8) Automatic thread breacking detecting
- 9) LCD screen
- 10) Touch computer control system
- 11) Imported Hook and Belt
- 12) Internet cable,usb driver
- 13) Built-in bobbin winder

Hoops/frames Included

- 1) 2 x Shirt Round Hoop 9 cm per head
- 2) 2 x Shirt Front Round Hoop 12 cm per head
- 3) 2 x Shirt Front Round Hoop 15 cm per head
- 4) 2 x Shirt Front Round Hoop 22 cm per head
- 5) 2 x Jacket Back Square Hoop 29 x 29 cm per head

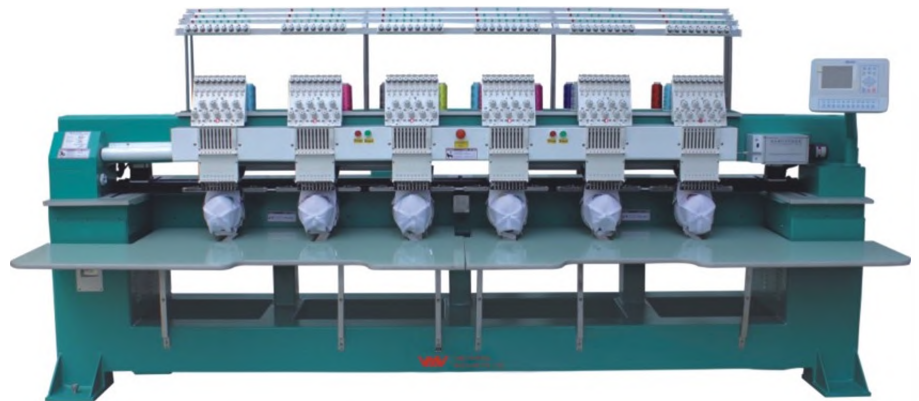

Cap Attachment Included

- 1) 2 x cap frames per head
- 2) 1 x cap driver per head
- 3) 1 x drive of cap frame every machine

Model	Head distance (mm)	Emb size (mm)	Head	Needl	Esmachine package size L · W · H(m)
FC-C901	400	400x450	1	9	1.5x1.3x1.7
FC-C902	400	400x450	2	9	2x1.3x1.7
FC-C904	400	400x450	4	9	2.8x1.3x1.7
FC-C906	400	400x450	6	9	3.6x1.3x1.7
FC-C908	400	400x450	8	9	4.4x1.3x1.7
FC-C910	400	400x450	10	9	5.2x1.3x1.7
FC-C912	400	400x450	12	9	6.0x1.3x1.7
FC-C1202	400	400x450	2	12	2x1.3x1.7
FC-C1204	400	400x450	4	12	2.8x1.3x1.7
FC-C1206	400	400x450	6	12	3.6x1.3x1.7
FC-C1208	400	400x450	8	12	4.4x1.3x1.7
FC-C1210	400	400x450	10	12	5.2x1.3x1.7
FC-C1212	400	400x450	12	12	6.0x1.3x1.7



Valuable Machine Accompany with you!



V-52S

COMPUTERIZED FLAT KNITTING MACHINE



Motor board



F400 master controller Touch screen



Handpiece



Probe warning device Yarn storage device



Needle gage: 5G, 7G, 9G, 12G, 13G, 14G, 16G

Handpiece: single head double system

Dimension: 2360 × 739 × 1750mm

Weight: 500kg

V-550W

ENERGY SAVING MIN MOTOR-REPLACE CLUTCH MOTOR

- 1) save energy 70%, garment factory could get back the cost in half-year
- 2) with external needle position function
- 3) control box could adjust the speed and other parameters
- 4) quality stable, noise smaller
- 5) could chose 750W use for heavy duty machine
- 6) direct drive machine also use this motor



Model			0 Nm	0 S.p.m		N W / /G W Kg
V-550W	AC220V	550W	1-3	4500	360x290x260	5.2/6.5
V-750W	AC220V	750W	1-3	3500	360x310x260	6/7

ACCESSORIES

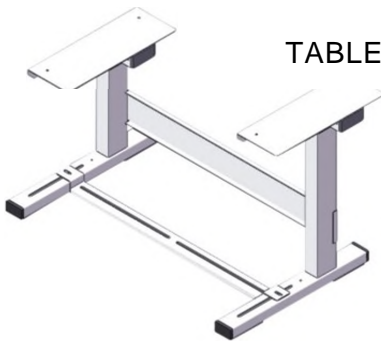

TABLE BRISTLE

Automatic adjust height stand

- Features:
- Max. Thrust: 1000N(perleg)
 - Max. Speed: 43mm/sec.
 - Stroke:400mm
 - Min Hight:720mm
 - Low noise leve
 - Motor size: 187x97x70mm
 - Input voltage:110/240V AC
 - Output voltage: 24V DC
 - Built-in limit switches(not adjustable)
 - Temperature: -5 degree to +40 degree

Bullmer

Lectur

Yin

Estman



Small wheels for sewing machine table & stand



Voltage transfer device
1 device can match with
3 sets electronic lockstitch



LED light

Provide Complete Sewing Solution

Архангельск (8182)63-90-72
Астана (7172)727-132
Астрахань (8512)99-46-04
Барнаул (3852)73-04-60
Белгород (4722)40-23-64
Брянск (4832)59-03-52
Владивосток (423)249-28-31
Волгоград (844)278-03-48
Вологда (8172)26-41-59
Воронеж (473)204-51-73
Екатеринбург (343)384-55-89
Иваново (4932)77-34-06

Ижевск (3412)26-03-58
Иркутск (395)279-98-46
Казань (843)206-01-48
Калининград (4012)72-03-81
Калуга (4842)92-23-67
Кемерово (3842)65-04-62
Киров (8332)68-02-04
Краснодар (861)203-40-90
Красноярск (391)204-63-61
Курск (4712)77-13-04
Липецк (4742)52-20-81
Киргизия (996)312-96-26-47

Магнитогорск (3519)55-03-13
Москва (495)268-04-70
Мурманск (8152)59-64-93
Набережные Челны (8552)20-53-41
Нижний Новгород (831)429-08-12
Новокузнецк (3843)20-46-81
Новосибирск (383)227-86-73
Омск (3812)21-46-40
Орел (4862)44-53-42
Оренбург (3532)37-68-04
Пенза (8412)22-31-16
Казахстан (772)734-952-31

Пермь (342)205-81-47
Ростов-на-Дону (863)308-18-15
Рязань (4912)46-61-64
Самара (846)206-03-16
Санкт-Петербург (812)309-46-40
Саратов (845)249-38-78
Севастополь (8692)22-31-93
Симферополь (3652)67-13-56
Смоленск (4812)29-41-54
Сочи (862)225-72-31
Ставрополь (8652)20-65-13
Таджикистан (992)427-82-92-69

Сургут (3462)77-98-35
Тверь (4822)63-31-35
Томск (3822)98-41-53
Тула (4872)74-02-29
Тюмень (3452)66-21-18
Ульяновск (8422)24-23-59
Уфа (347)229-48-12
Хабаровск (4212)92-98-04
Челябинск (351)202-03-61
Череповец (8202)49-02-64
Ярославль (4852)69-52-93